

Order # :

Xtreme-16 80x140-1R1G1B

120V / 1656W / 14A / 364LBS / Per Face

Please Keep For Service!



Support@thinksign.com

www.ThinkSign.com

NOTES:

- 1.DISPLAY IS REAR VENTILATED, DO NOT BLOCK UP VENTILATORS.
- 2.FRONT ACCESS FOR SERVICE.
- 3.THINKSIGN IS NOT RESPONSIBLE FOR THE MAIN ELECTRICAL DISCONNECT.
- 4.THINKSIGN IS NOT RESPONSIBLE FOR THE MOUNTING HARDWARE OR THE INTEGRITY OF THE STRUCTURE THE DISPLAY IS MOUNTED TO.

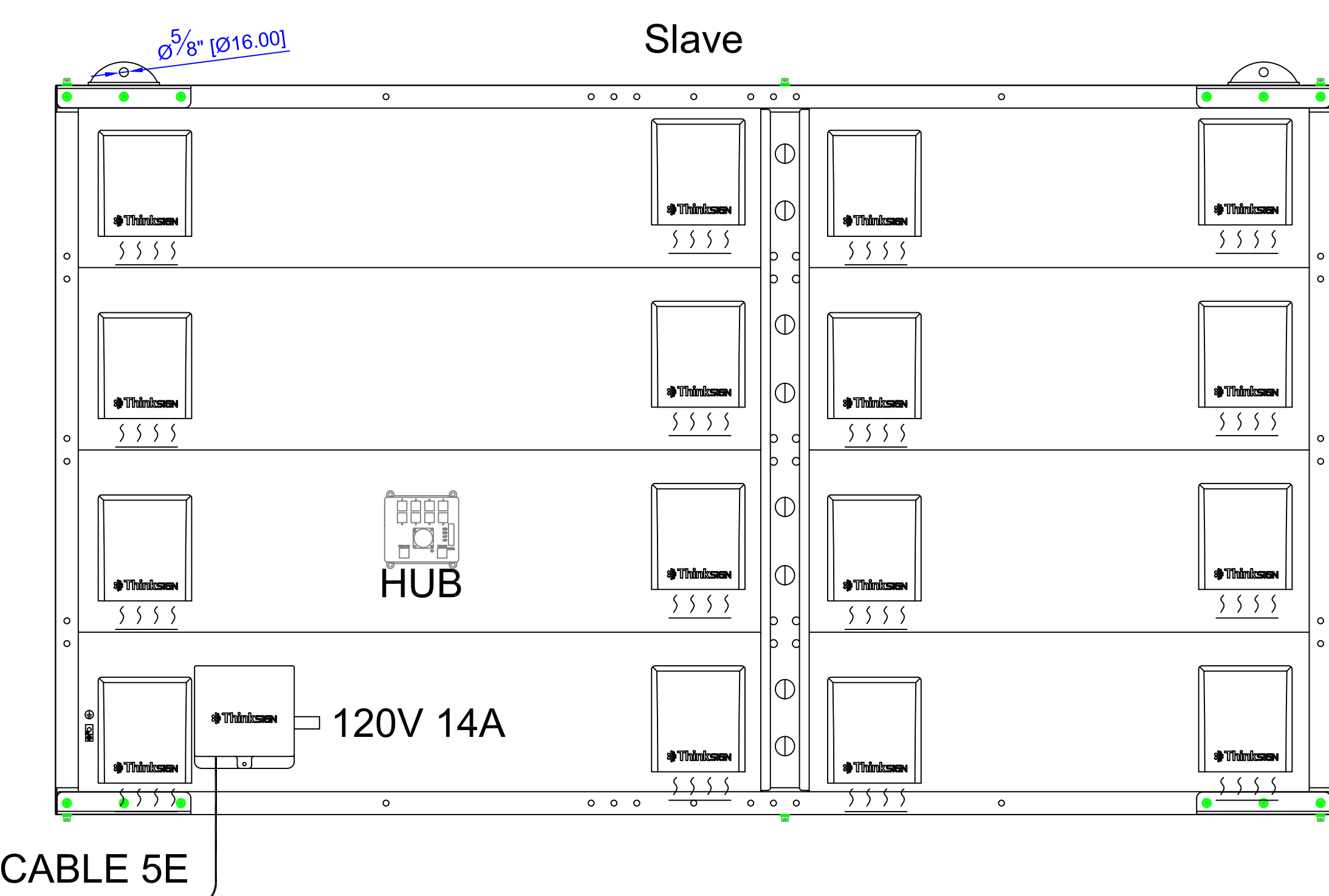
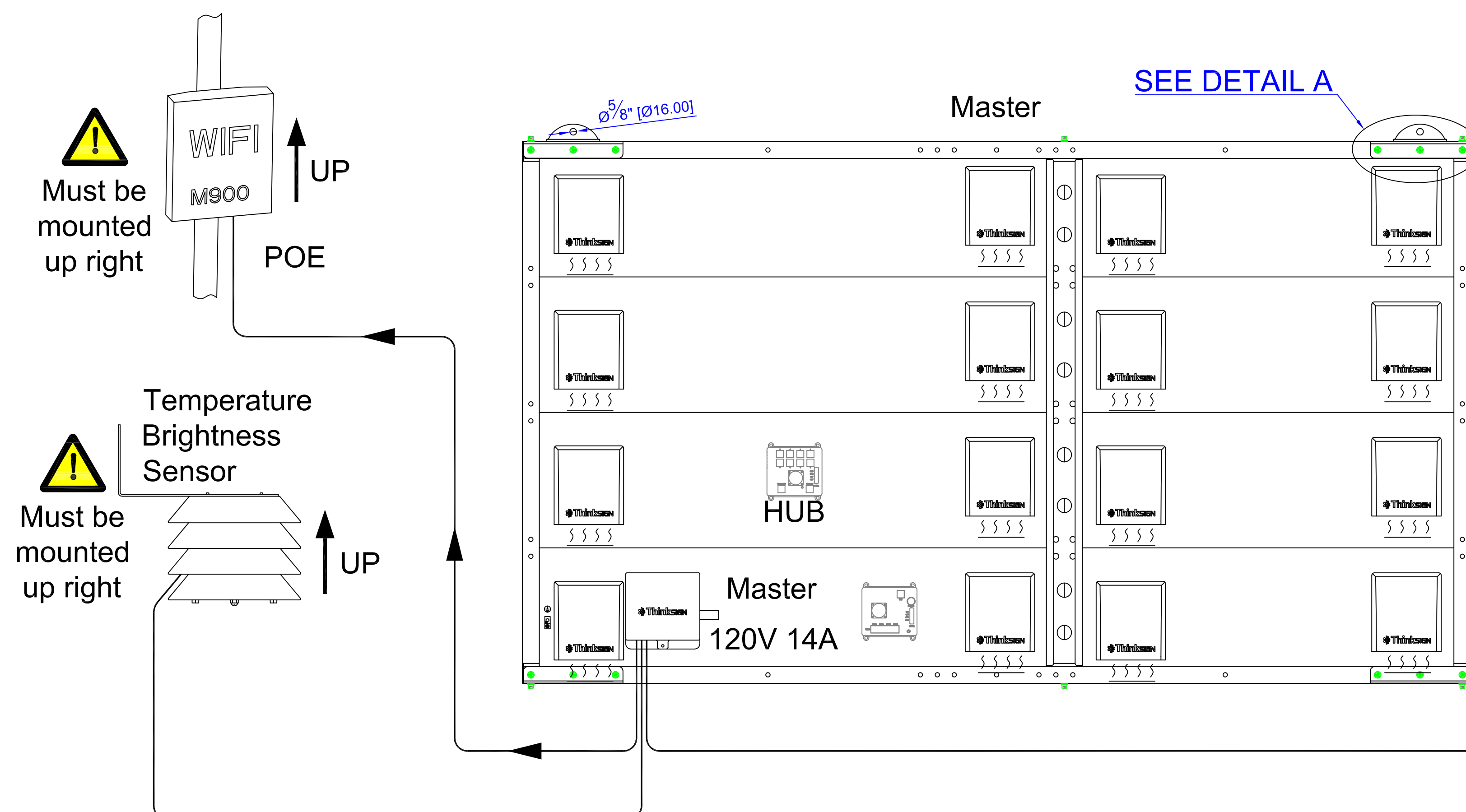
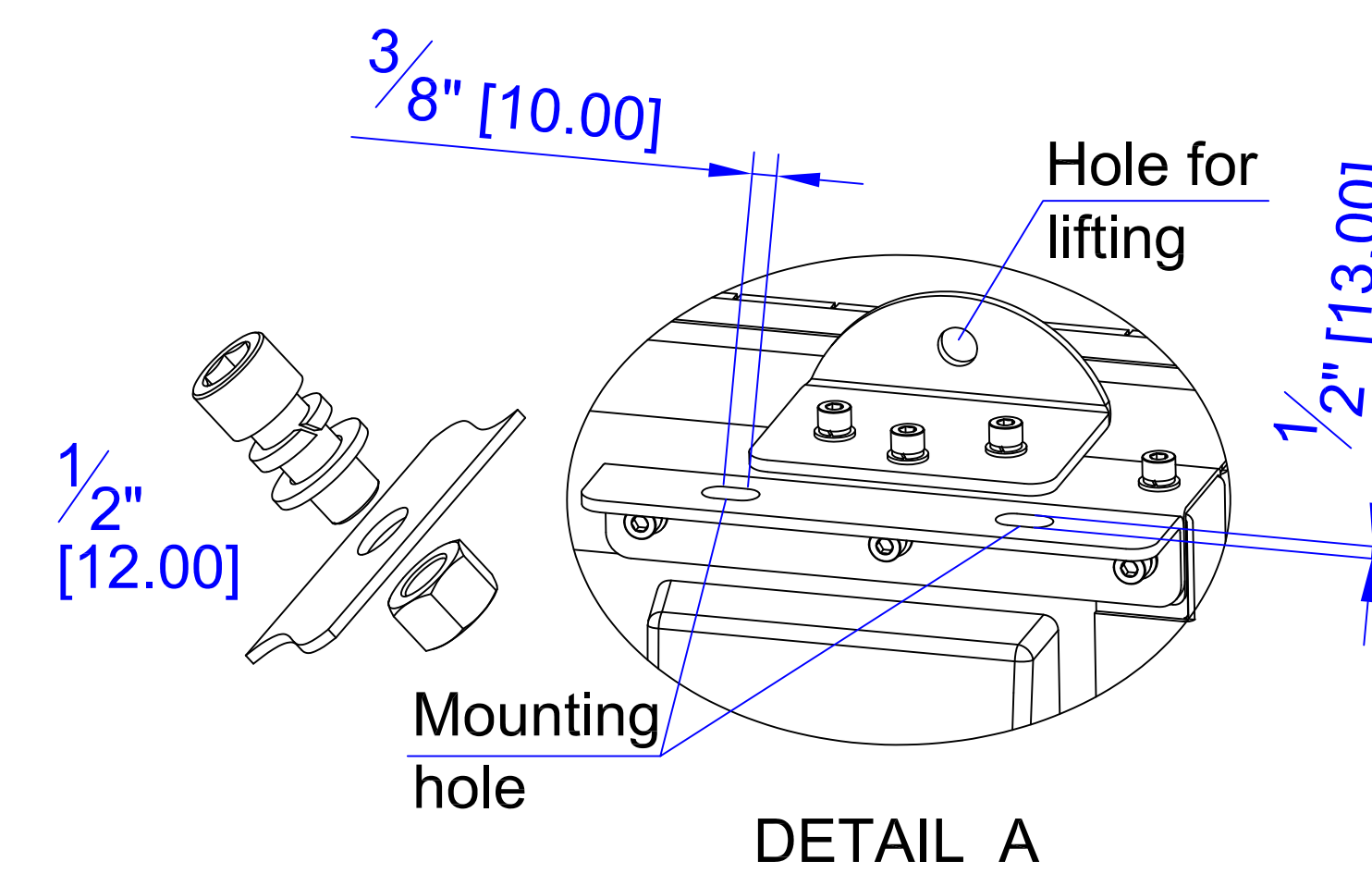
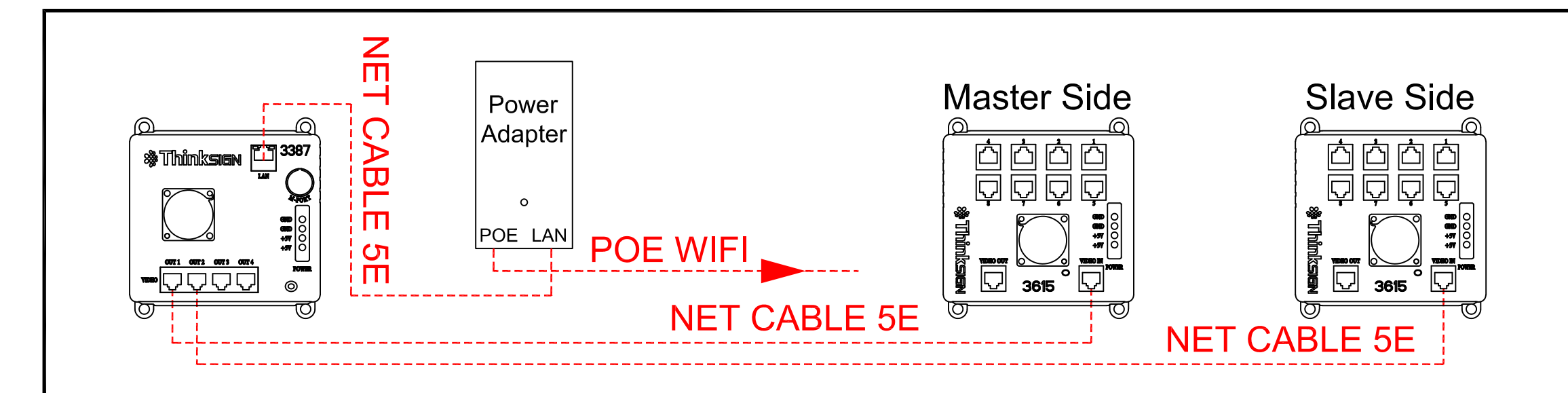
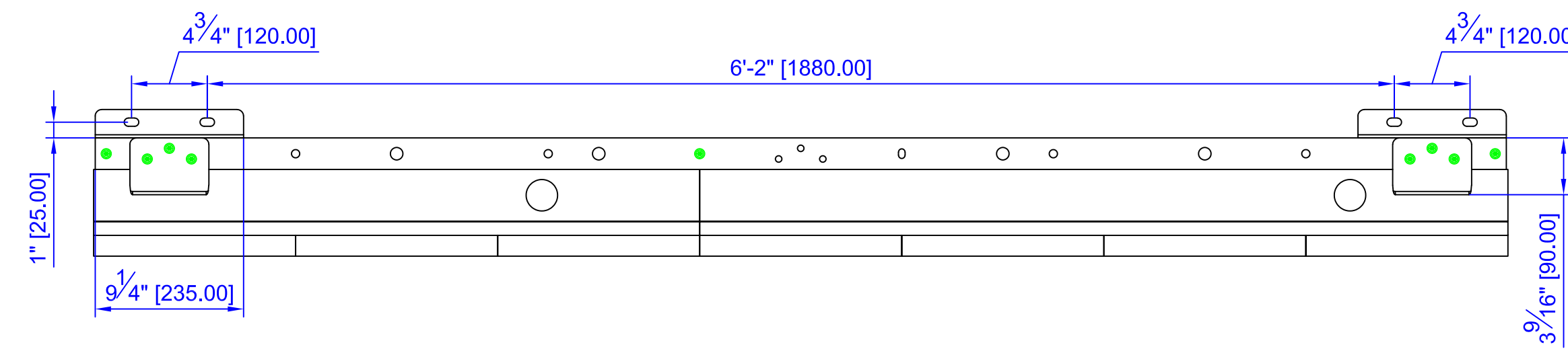
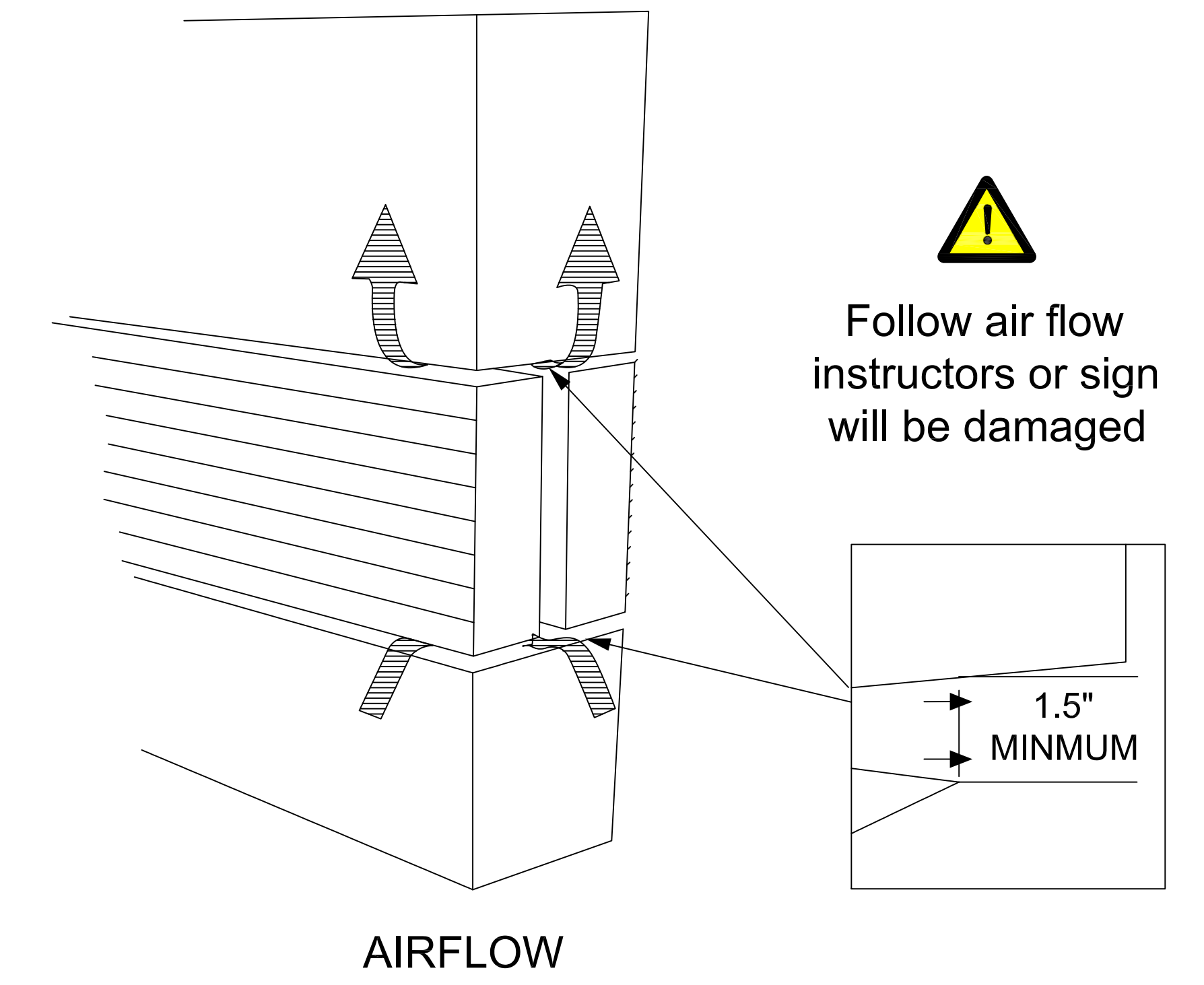
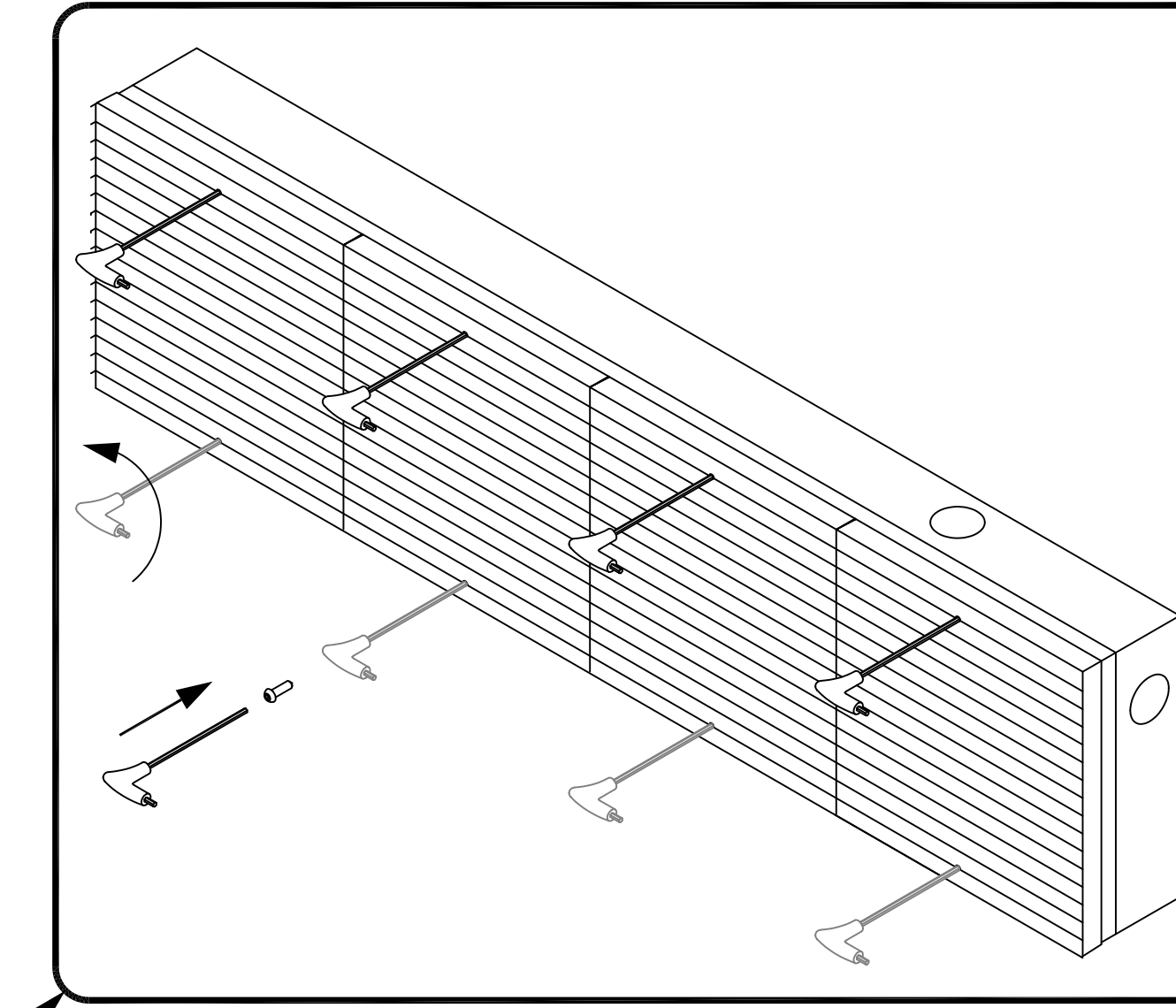
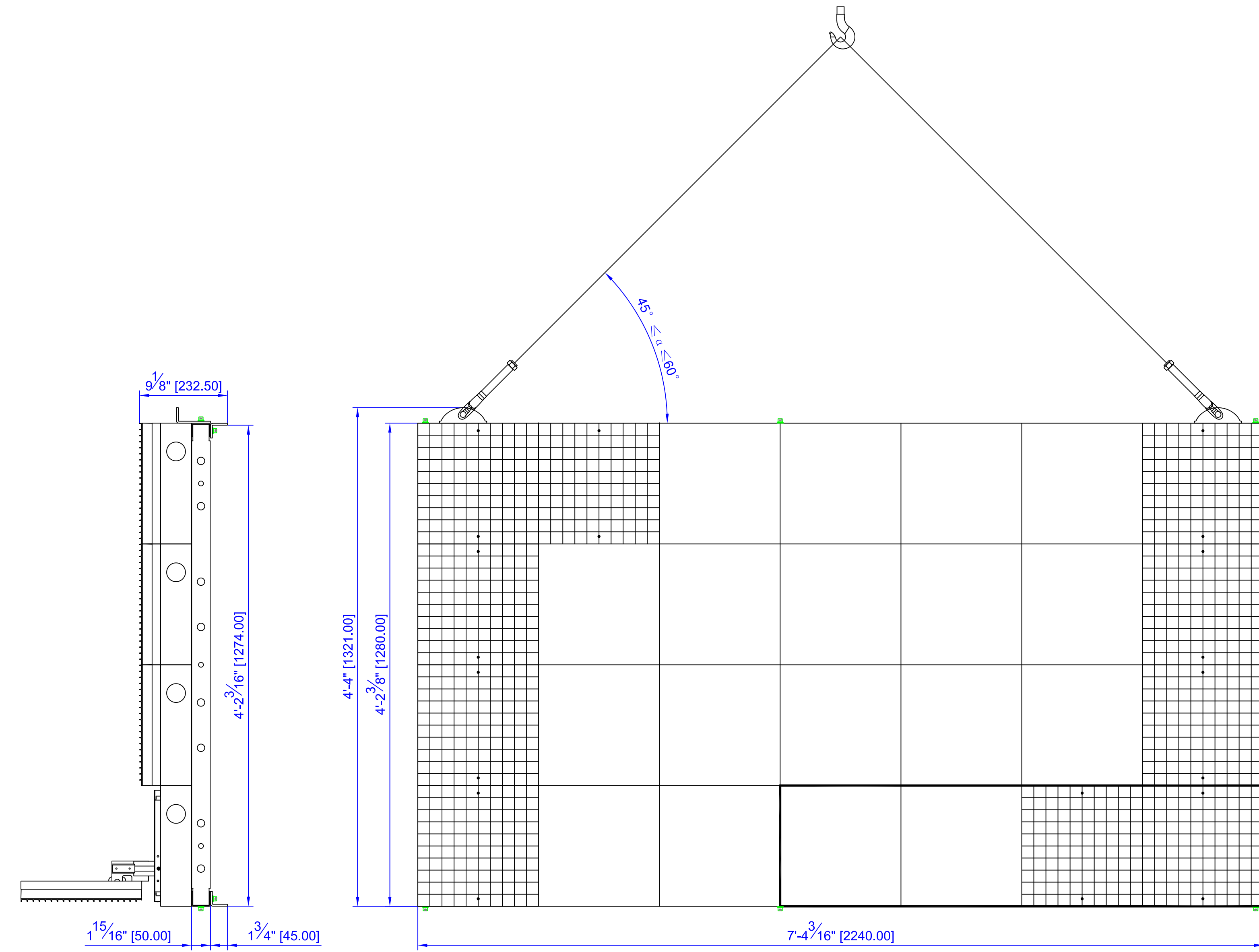

Installing & Replacing the Wireless Package

The ThinkSIGN LED displays that are ordered with the wireless package are shipped pre-configured. The radios are meant to be plug-and-play, with little to no IT experience needed.

The Sender

- Plug a cable into the LAN port of the sender.
- Plug the POE unit power into the wall and plug the cable from the sending unit into the "POE" port.
- Plug a cable from the LAN port of the POE to an open port on your router or switch.
- Mount the sending unit and turn on the sign.
- After 2-3 minutes, the radios should sync up and you should be able to connect to your sign successfully after installing the Smart LED Manager Pro software.



The Receiver

- The receiver is configured and shipped with the unit and plugged into the master side of the sign.
- Plug in the cable marked "Wi-Fi" into the LAN port of the receiver.
- Next, mount the receiver vertically on an external area of the sign/pole facing the direction of the site the sender will be installed.



Wifi Communication Setup



Click on the sync button on the software homepage.

Next, click on the [Connection Guide](#)

