

Order # :
 Xtreme-10 96x320-SMD 3 In 1
 120V / 2746W / 23A / 422LBS / Per Face



Support@thinksign.com
 www.ThinkSign.com

- NOTES:
 1.DISPLAY IS REAR VENTILATED, DO NOT BLOCK UP VENTILATORS.
 2.FRONT ACCESS FOR SERVICE.
 3.THINKSIGN IS NOT RESPONSIBLE FOR THE MAIN ELECTRICAL DISCONNECT.
 4.THINKSIGN IS NOT RESPONSIBLE FOR THE MOUNTING HARDWARE OR THE INTEGRITY OF THE STRUCTURE THE DISPLAY IS MOUNTED TO.

Please Keep For Service!

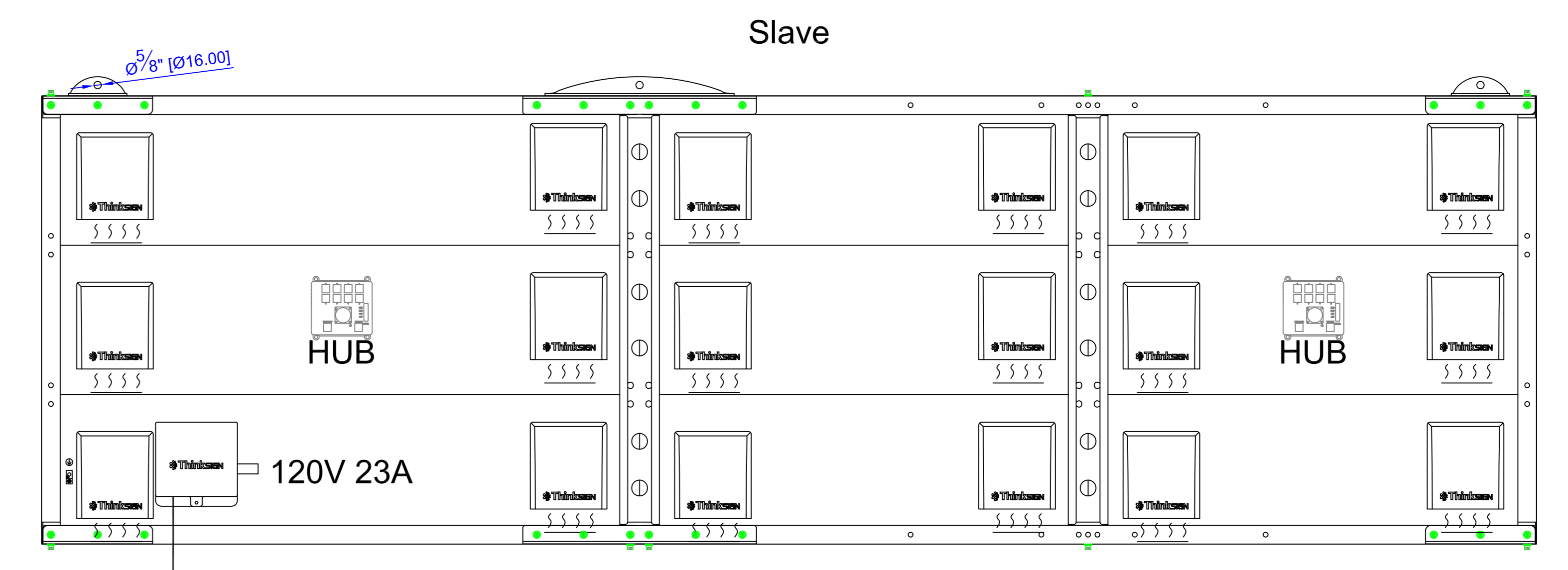
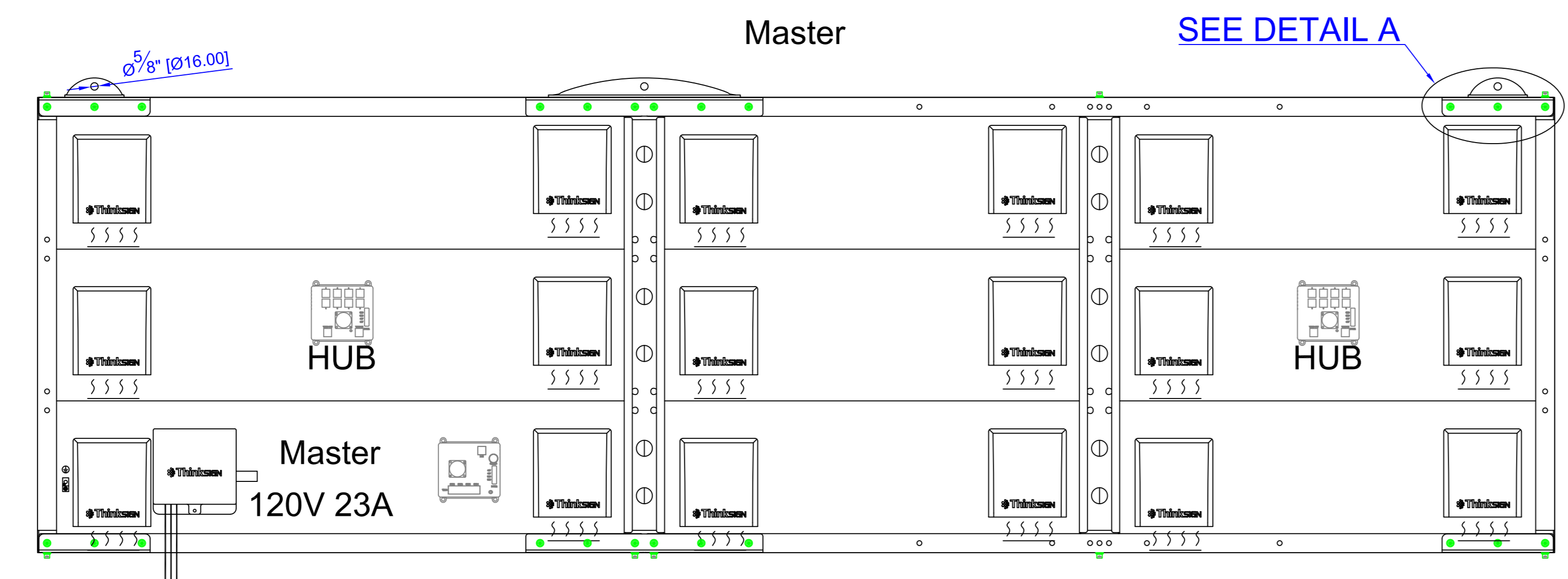
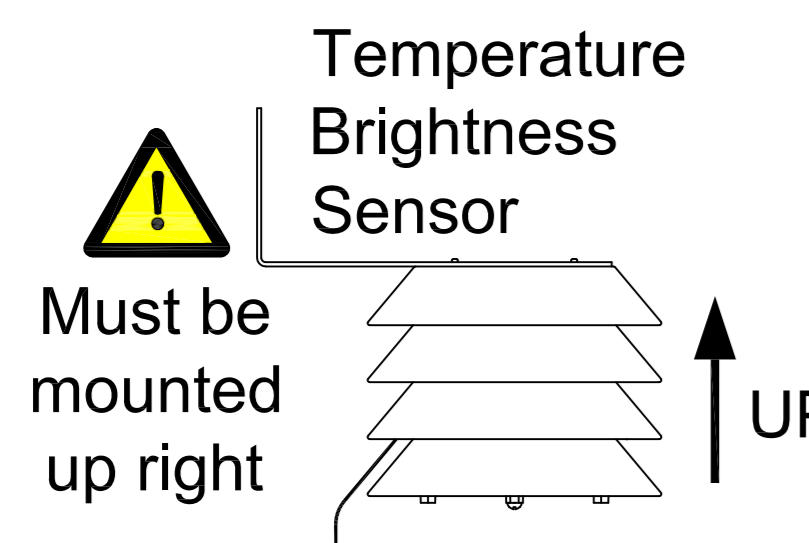
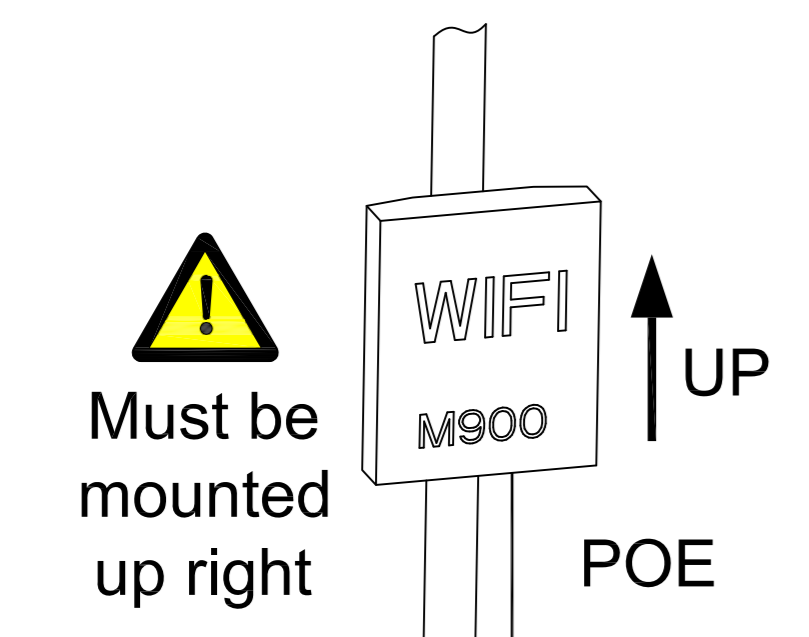
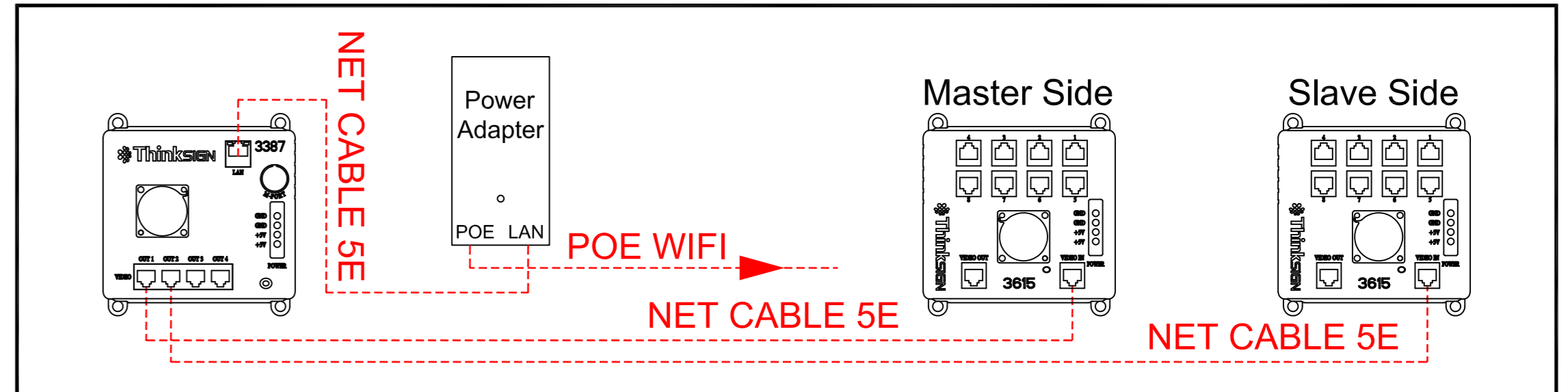
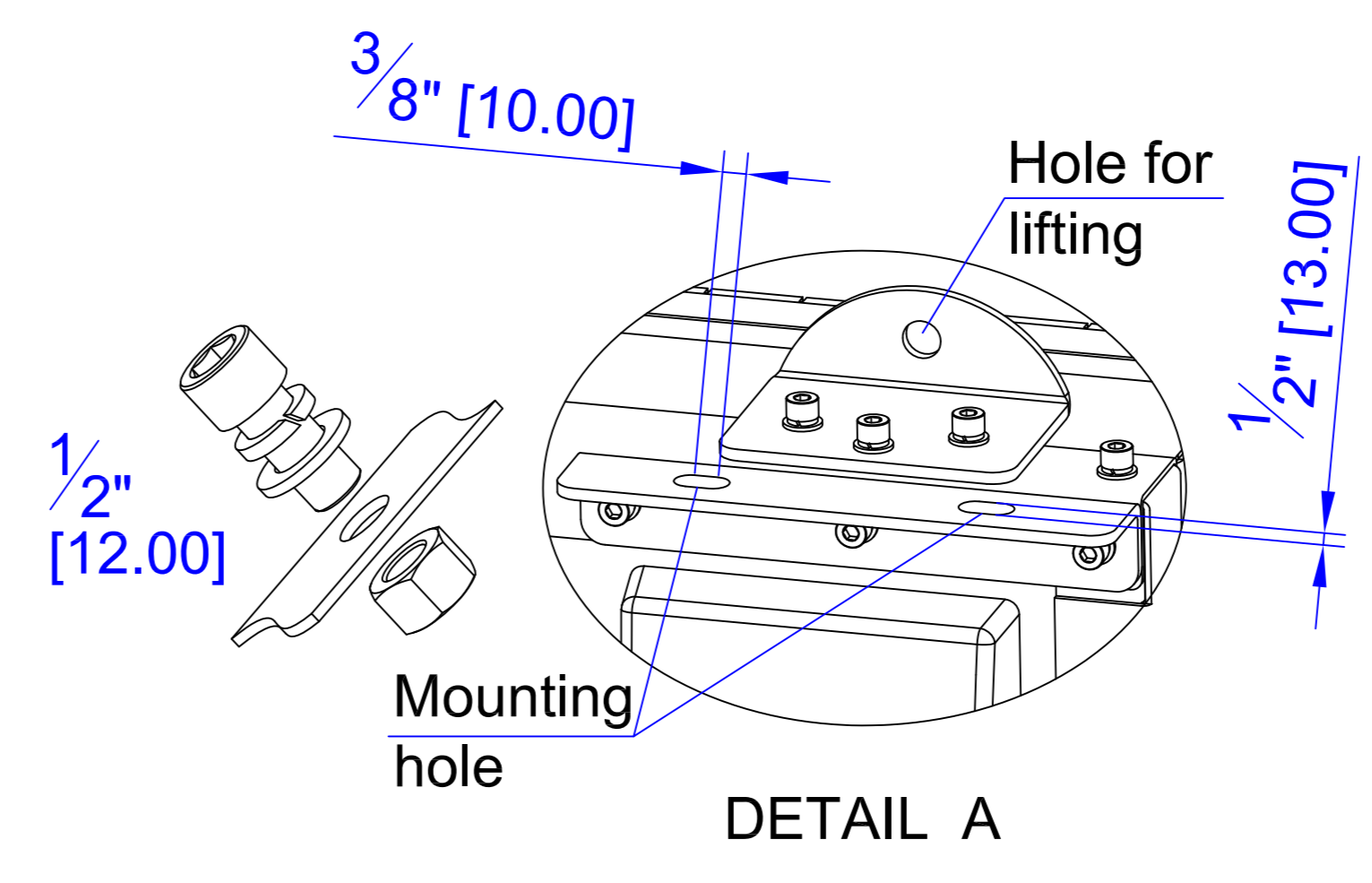
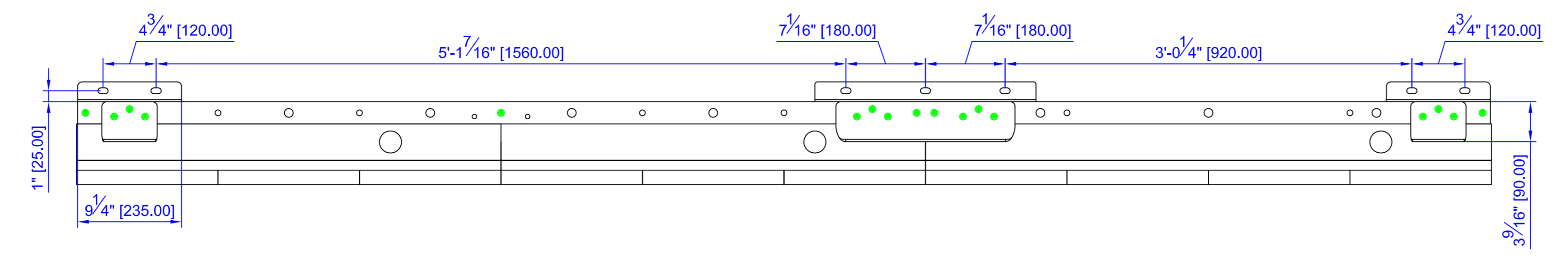
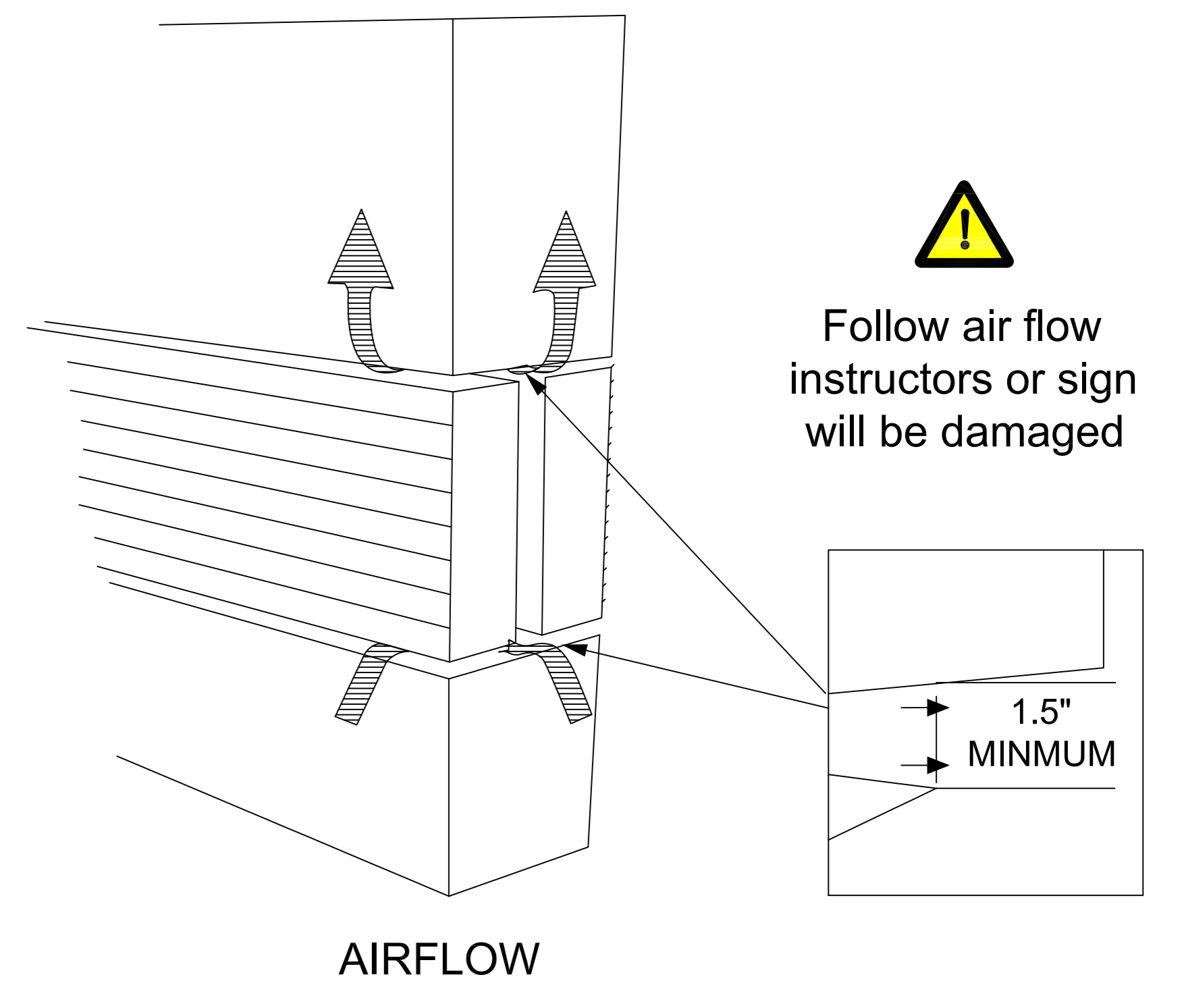
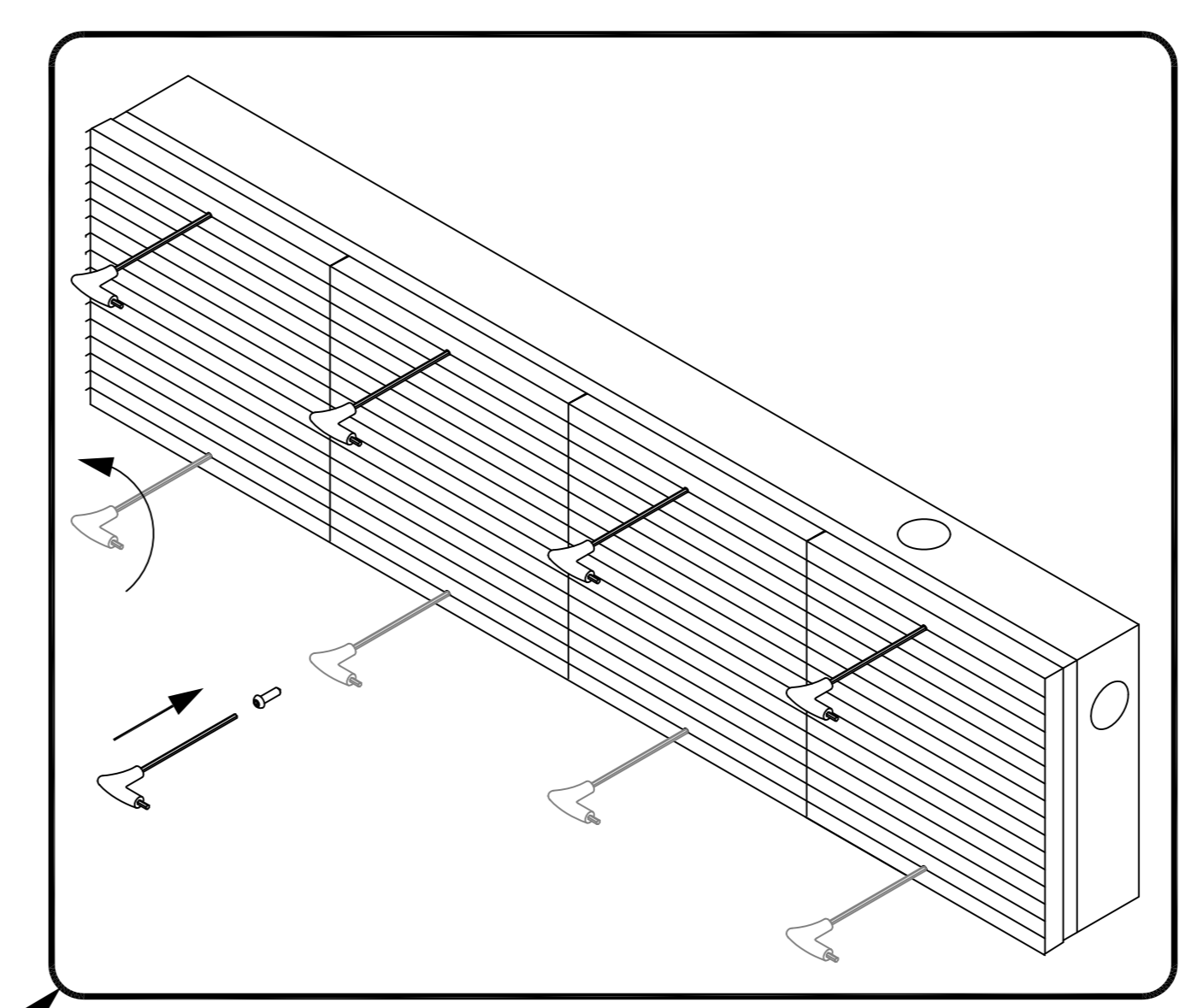
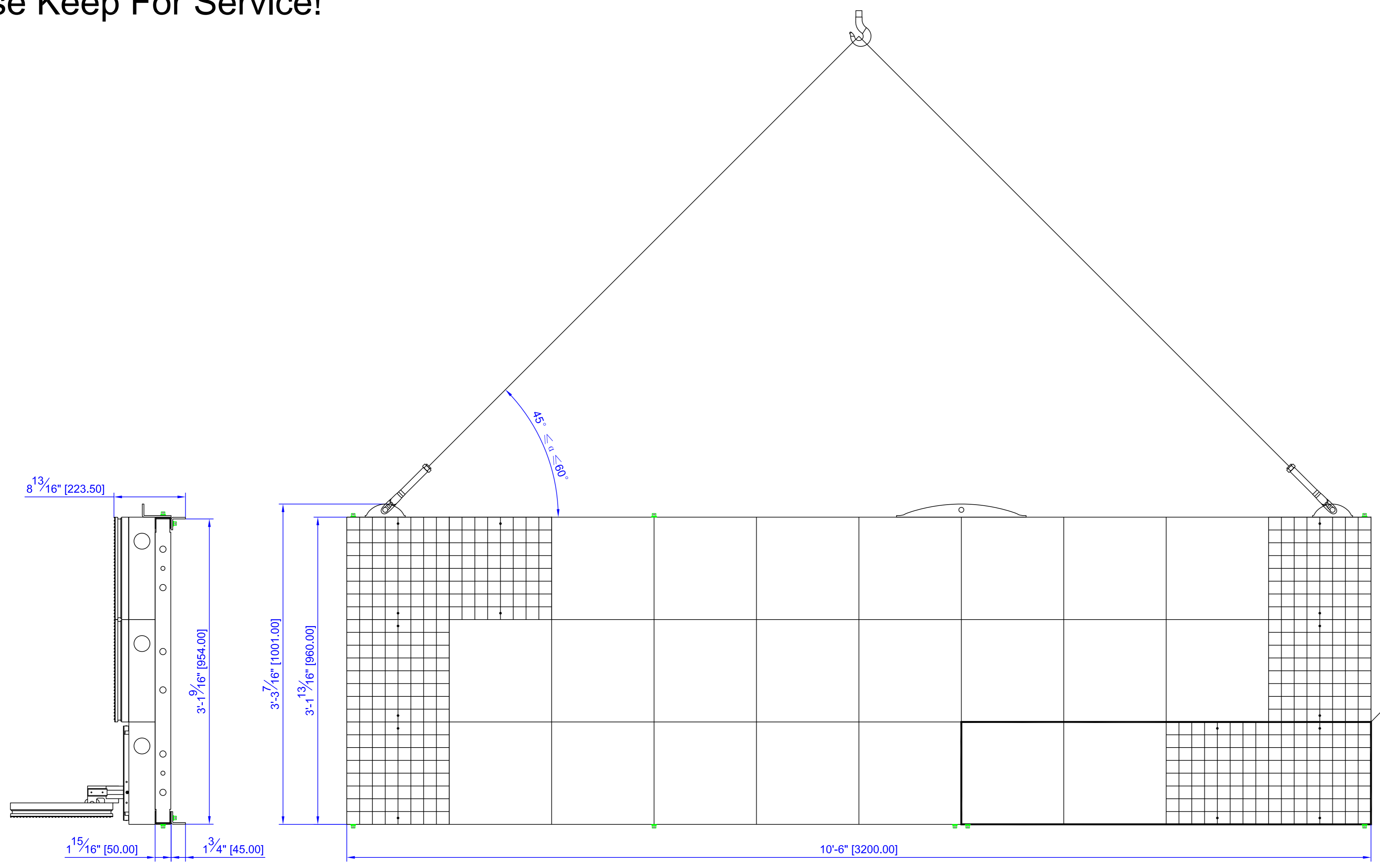

NET CABLE 5E

Installing & Replacing the Wireless Package

The ThinkSIGN LED displays that are ordered with the wireless package are shipped pre-configured. The radios are meant to be plug-and-play, with little to no IT experience needed.

The Sender

- Plug a cable into the LAN port of the sender.
- Plug the POE unit power into the wall and plug the cable from the sending unit into the "POE" port.
- Plug a cable from the LAN port of the POE to an open port on your router or switch.
- Mount the sending unit and turn on the sign.
- After 2-3 minutes, the radios should sync up and you should be able to connect to your sign successfully after installing the Smart LED Manager Pro software.



The Receiver

- The receiver is configured and shipped with the unit and plugged into the master side of the sign.
- Plug in the cable marked "Wi-Fi" into the LAN port of the receiver.
- Next, mount the receiver vertically on an external area of the sign/pole facing the direction of the site the sender will be installed.



Wifi Communication Setup



Click on the sync button on the software homepage.

Next, click on the [Connection Guide](#)

